

TRANSITIONS, DAMPERS, & ADAPTORS



Model 411 Transition

- 3 1/4" x 10" to 6" round
- Model 412H Transition**
- 3 1/4" x 10" to 7" round
- Model 413 Transition**
- 3 1/4" x 10" to 8" round

All models above -
30 GA galvanized steel
construction

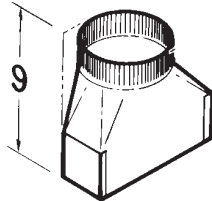

Model 423 Transition

- 4 1/2" x 18 1/2" to 10" round
- vertical discharge
- 26 GA galvanized steel
construction

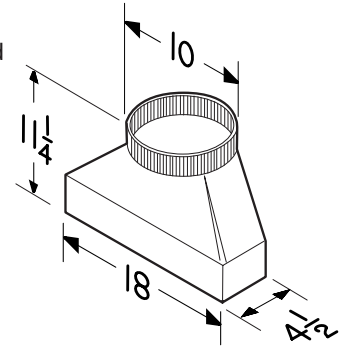

Model 414 Transition

- 10" round to 8" round
- 24 GA galvanized steel

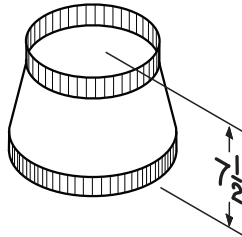

Model 424 Transition

- 4 1/2" x 18 1/2" to 10" round
horizontal, rear discharge
- 26 GA galvanized steel
construction

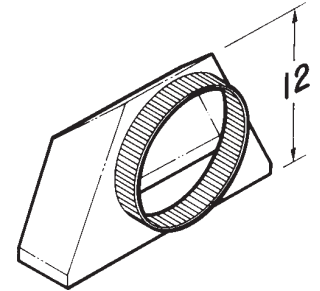

Model T486 Transition

- 8" round to 6" round
- 30 GA galvanized steel

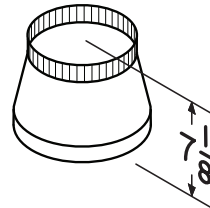

Model 427 Transition

- 4 1/2" x 18 1/2" to 10" round
horizontal discharge
- 26 GA galvanized steel
construction

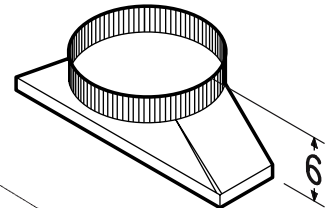

Model T487 Transition

- 8" round to 7" round
- 24 GA galvanized steel

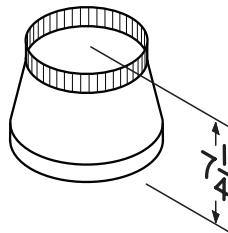

Model 453 Transition

- 4 1/2" x 18 1/2" to 10" round
horizontal, left discharge
- 26 GA galvanized
steel construction

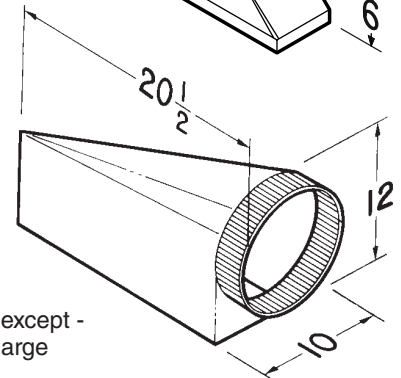

Model 454 Transition

- Same as Model 453 except -
horizontal right discharge

Broan Hartford, Wisconsin www.broan.com 800-637-1453 www.nutone.com 888-336-3948
BEST Hartford, Wisconsin www.BestRangeHoods.com

REFERENCE	QTY.	REMARKS	Project
			Location
			Architect
			Engineer
			Contractor
			Submitted by Date

Model 459 Transition

- 3 1/4" x 14" to 8" round - vertical discharge
- 30 GA galvanized steel construction

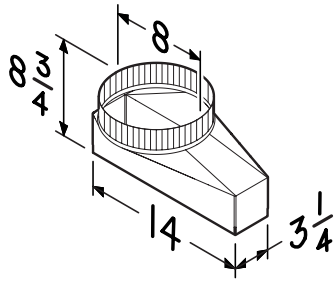

Model T460 Transition

- 3 1/4" x 14" to 7" round - vertical discharge
- 30 GA galvanized steel construction

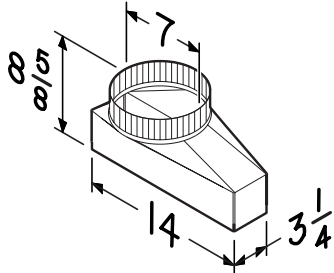

Model T462 Transition

- 3 1/4" x 14" to 6" round - vertical discharge
- 30 GA galvanized steel construction

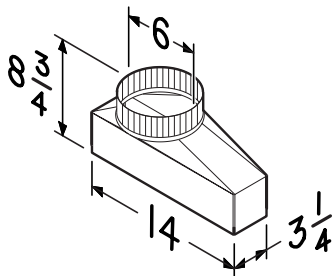

Model 472 Transition / Damper

- 10" round to 8" round
- Spring-loaded aluminum louvers
- Rubber stops
- 24 GA galvanized steel

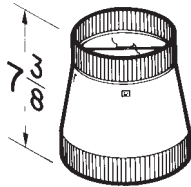

Model 475 Transition

- 6" round to 4" round
- Black, polymeric construction

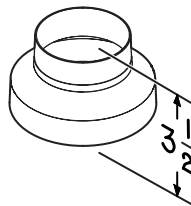

Model 475B Transition

- Six-pack of Model 475

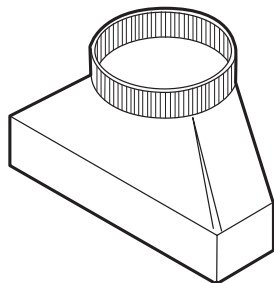

Model T81212 Transition

- 8" x 12" to 12" round
- 28 ga. galvanized steel

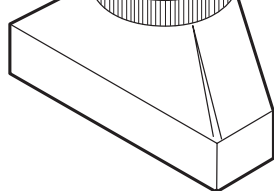

Model S99610015 Transition

- 8" x 12" to 10" round male - vertical discharge
- 26 GA galvanized steel construction

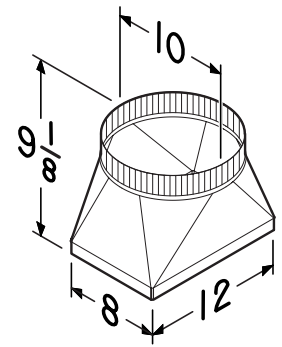

Model S99610028 Transition

- 8" x 12" to 10" round female - vertical discharge
- 26 GA galvanized steel construction

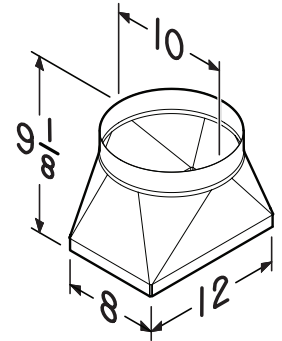

Model AVDKD8 Transition

Model ATKD8 Transition

- 1-7/8" x 19" to 8" round
- 26 GA galvanized steel construction
- Includes duct slips (Model ATKD8 only)
- Includes 2 barrel nuts for attachment. (Model AVDKD8 only)

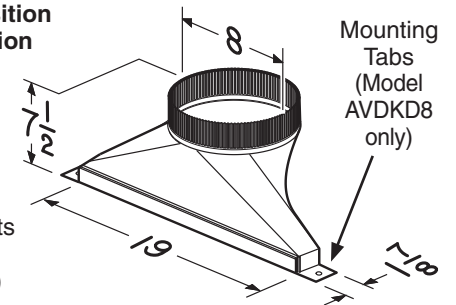

Model AVDKD10 Transition

Model ATKD10 Transition

- 1-7/8" x 19" to 10" round
- 26 GA galvanized steel construction
- Includes duct slips (Model ATKD10 only)
- Includes 2 barrel nuts for attachment. (Model AVDKD10 only)

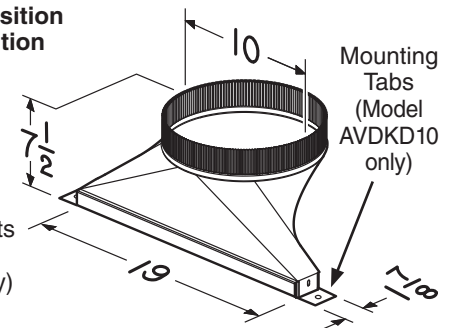

Model AVDKD8810

Model ATKD8810

- Y-Duct Connector
- 10" round to dual 8" round
- 26 GA galvanized steel construction

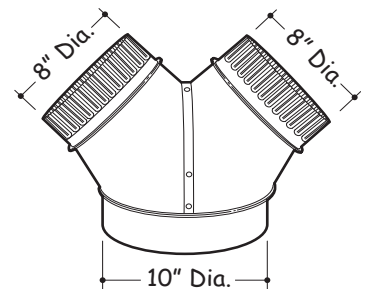

Broan Hartford, Wisconsin www.broan.com 800-637-1453

Broan Hartford, Wisconsin www.nutone.com 888-336-3948

BEST Hartford, Wisconsin www.BestRangeHoods.com

Model BP87Q Damper

- 7" round
- Extruded steel with electrically-bonded epoxy finish
- .016 Aluminum louvers
- Sound dampening foam

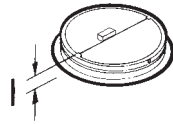

Model T457 Transition

- 7" round to 5" round
- 30 GA galvanized steel
- Can be use with BP87Q

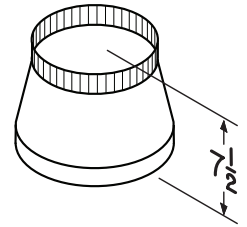

Model 97 Damper

- 7" round
- 28 GA galvanized steel
- Aluminum louvers

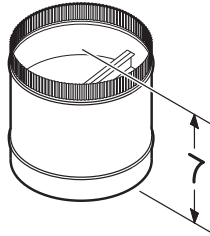

Model 463B Expander

- 3" round to 4" round
- Black, polymeric construction

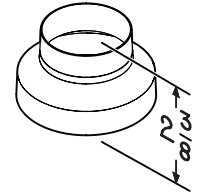

Model 421 Damper

- 10" round
- 24 GA galvanized steel with aluminum louvers

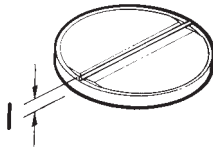

Model 465B Expander

- 4" round to 5" round
- Black, polymeric construction

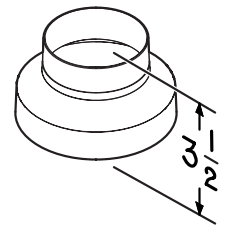

Model 438 Damper

- 8" round
- 24 GA galvanized steel with aluminum louvers

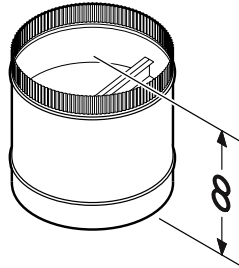

Model AVDKD219

Model ATKD219

Adaptor

- Adapts to 1-7/8" x 19" duct
- 22 GA galvanized steel construction
- Includes 2 barrel nuts for attachment

